

**Cmax™/Amsco® 3085 SP/3080
Orthopedic Extension
Set-up Guide**



Table of contents

Summary of warnings	A
Compatibility, Intended use, Attachment to table	B
Attachment of accessories	C
Storage	D
Right hip pinning, bilateral traction	1
Left hip pinning, bilateral traction	2
Right hip pinning, unilateral traction	3
Left hip pinning, unilateral traction	4
Right IM nailing, supine position	5
Left IM nailing, supine position	6
Right IM nailing, supine position, with skeletal traction	7
Left IM nailing, supine position, with skeletal traction	8
Right IM nailing, lateral position	9
Left IM nailing, lateral position	10
Right IM nailing, lateral position, alternate set-up	11
Left IM nailing, lateral position, alternate set-up	12
Right IM nailing, lateral position, with skeletal traction	13
Left IM nailing, lateral position, with skeletal traction	14
Right IM nailing, lateral position, with skeletal traction, alternate set-up	15
Left IM nailing, lateral position, with skeletal traction, alternate set-up	16
Right tibia/fibula	17
Left tibia/fibula	18
Orthopedic accessories	19-20

Cmax/ 3085 SP/ 3080 Orthopedic Extension

Summary of Warnings

ADVISORY - The photos in this brochure are intended to provide general guidance on table setup and patient positioning for the surgical procedures shown. Actual circumstances and the patient's medical conditions may necessitate modifications that must be made in accordance with good medical practice.

Following is a list of the safety precautions that must be observed when using the Cmax/3085 SP/3080 Orthopedic Extension. WARNINGS indicate the potential for danger to personnel. It is important to review these precautions before using the product. The user must also read and follow all instructions, warnings and cautions that were supplied with or are shown on the Cmax, Amsco 3085 SP or 3080-series table being used.

WARNING - HAZARD:

- ⚠ Tipping hazard can cause patient or user injury.
 - Do not exceed 400 pound (181 kg) maximum patient weight.
 - Always check table stability when patient is positioned.
 - Do not use table unless floor locks are engaged.
 - Do not release table floor locks while patient is on table.

WARNING - POSSIBLE PATIENT OR USER INJURY:

- ⚠ Do not leave patient unattended on table.
- ⚠ Healthcare professionals must ensure that patients are positioned and monitored so as to prevent compromising respiration, nerve pathways or circulation.

⚠ Always secure patient for the surgery being performed in accordance with good medical practice using appropriate patient restraints. Some patient restraints may not be identified or may not have been shown in the accompanying photos.

⚠ Check table and accessories for damage or wear prior to each use. Do not use if any damage is apparent or device cannot be securely tightened.

⚠ To prevent accessory movement, gravity locks on each side of mounting bracket must interlock with seat section siderail standoffs of seat section. Securely tighten siderail locking knobs.

WARNING - PERSONNEL INJURY HAZARD:

⚠ Use two people when attaching or removing the Cmax/ 3085 SP/3080 Orthopedic Extension.

WARNING - PERSONNEL INJURY/EQUIPMENT DAMAGE HAZARD:

⚠ Do not use the Cmax /3085 SP/3080 Orthopedic Extension with any other table than a STERIS Cmax™, an Amsco® 3085 SP, or an Amsco® 3080-series Surgical Table.

⚠ Do not raise the leg section or press return-to-level on the hand control while the Cmax/3085 SP/3080 Orthopedic Extension is attached.

WARNING - EXPLOSION HAZARD:

⚠ Table must not be used in the presence of flammable anesthetics.

COMPATIBILITY

This accessory is adaptable to **Cmax™ Surgical Tables** as well as to **Amsco® 3080** and **3085 Surgical Tables** (models RC, RL, and SP).

INTENDED USE

This easy-to-use radiolucent orthopedic extension is designed for attachment to the seat section of Cmax, Amsco 3085 SP or 3080 Surgical Tables to provide a mobile, radiolucent, orthopedic platform. It provides flexible, articulated posturing of patients for orthopedic procedures requiring leg traction.

NOTE: Read and follow all instructions, warnings and cautions that were supplied with or are shown on the Cmax, 3085 SP, 3080 RC, RL, SP table being used.

ATTACHMENT TO TABLE

1. Verify that all components of the Cmax/ 3085 SP/ 3080 Orthopedic Extension package are present (Figure 1).

These are:

- A. abductor bar system
- B. accessory cart
- C. wedge-shaped sacral rest with pad
- D. perineal post with pad
- E. carbon fiber traction unit assemblies (2)
- F. L-shaped traction extensions (2)
- G. traction boots (adult, pair)
- H. traction accessory clamps (2)
- I. armboard with 2" pad
- J. multi-posture armboard
- K. Clark socket
- L. universal legholder
- M. patient transfer board with 4" pad

See pages 19-20 for a picture of each item.

Other accessories may be needed for certain procedures.

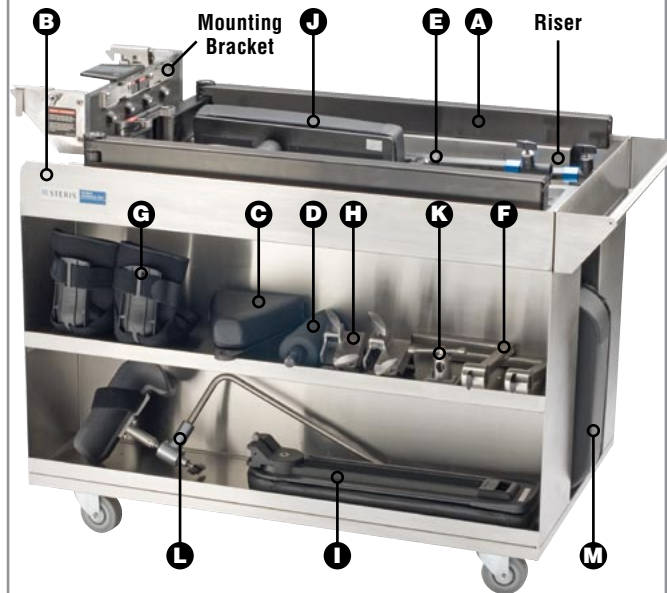

Figure 1 – Orthopedic Extension Accessory Package

2. Place the orthopedic extension on top of the risers on the accessory cart with the abductor bars locked at joints in the appropriate positions: inner bars (short sections) rotated outward 90° and the outer bars (long sections) perpendicular to the inner bars and mounting bracket. The mounting bracket must be at the end opposite the cart's push handle (see Figure 1).

3. Make sure the table's floor locks are engaged.

4. Remove head section and X-ray cassette tops from the surgical table.



Figure 2 – Amsco 3085 SP table

5. Make sure the table is positioned to "LEVEL."

a. If applying the orthopedic extension to a 3085 SP/3080 table, remove the leg section pad and completely

lower the leg section of the table (see Figure 2), exposing the perineal cutout area on the seat section of the table.



Figure 3 – Cmax table

b. If applying the orthopedic extension to a Cmax table, remove the leg section of the table to expose the seat section of the table (see Figure 3). After removing the leg section, lower the leg section receptacles completely;

do not raise the leg section receptacles at any time while the orthopedic extension is attached.

6. Determine procedure to be used; then use the Cmax /3085 SP/3080 Orthopedic Extension Set-Up Procedure Guide for positioning recommendations. Place appropriate accessories on the shelves of the cart. Reference pages 19-20 for pictures of each item.

7. Wheel the cart with extensions to the table with the mounting bracket facing the seat section of the table. The seat section is the **ONLY** area on the table where the extension system is to be mounted.



Figure 5 - Attaching the orthopedic extension



Figure 6 - Lift it onto table



Figure 7 - Tighten siderail locking knobs



Figure 8 - Table pad reversed

WARNING - PERSONAL INJURY HAZARD: Use two people when attaching or removing the orthopedic extension.

8. Raise the table to its maximum height so that the orthopedic extension can be moved onto the siderails of the seat section.

9. Attach the orthopedic extension as follows:

- a. Loosen each siderail locking knob completely (Figure 4).
- b. With one person standing on each side of the cart, grab the siderail locking knob with one hand and the abductor bar with the other hand (Figure 5). Lift slightly and slide the mounting bracket completely onto the siderails until gravity locks fall into place (Figure 6).
- c. Firmly tighten the siderail locking knobs to secure the extension to the table (Figure 7).



Figure 4 - Gravity latch (left) shown raised, siderail locking knob (right) loosened

WARNING - PREVENT POSSIBLE PATIENT OR USER INJURY: To prevent accessory movement, the gravity locks on each side of the mounting bracket must interlock with siderail standoffs of the seat section. Securely tighten siderail locking knobs.

- d. Remove accessory cart from the operating area.

10. Place the back/seat section pad back on the table with the pad in a reversed position in order to cover the perineal cutout area (Figure 8).

CAUTION - POSSIBLE EQUIPMENT DAMAGE HAZARD: Do not raise the leg section or press the return-to-level button on the hand control while the orthopedic extension is attached.

11. Follow the appropriate guidelines in this document.

ATTACHMENT OF ACCESSORIES

WARNING - PREVENT POSSIBLE PATIENT OR USER INJURY: Check table and accessories for damage or wear prior to each use. Do not use if any damage is apparent or device cannot be securely tightened.

NOTE: It is beneficial to add as many accessories as possible to the orthopedic extension before the patient transfer board is removed.

1. To install accessories on the abductor bars:

- a. Place traction accessory clamp on the abductor bar and tighten the lower thumb screw to maintain clamp position.
- b. Insert accessory in the clamp and tighten outside thumb screw.
- c. If adjustment is needed in clamp position, loosen lower thumb screw on traction accessory clamp and slide along abductor to the desired position.

STORAGE

1. When the procedure is complete, thoroughly clean and disinfect the table, orthopedic extension, and all accessories per facility procedures.

2. Remove the abductor bars as follows:

- a. Lock abductor bars in the appropriate position: inner bars (short sections) rotated outward 90° and the outer bars (long sections) perpendicular to the inner bars and mounting bracket (Figure 9).

NOTE: To reposition an abductor bar, loosen the siderail locking knob below the bar, move the bar to the desired position, then retighten the knob. When securing the abductor bars, make sure the rosette joints nest together properly when tightening to prevent premature wear (see Figures 10-11). Tighten securely.

- b. Raise the table and position the accessory cart under the abductor bars.

WARNING - PERSONNEL INJURY HAZARD: Use two people when attaching or removing the Cmax/3080/3085 SP Orthopedic Extension.

- c. Using two people, one person standing on each side of the table, loosen the siderail locking knobs (Figure 12).
- d. Each person grab a siderail locking knob with one hand and the abductor bar with the other hand (Figure 13), then slide the orthopedic extension off of the table. Hold gravity locks up to clear siderail standoffs (Figure 14-15). Place on top of the risers of the accessory cart as shown (Figure 16).

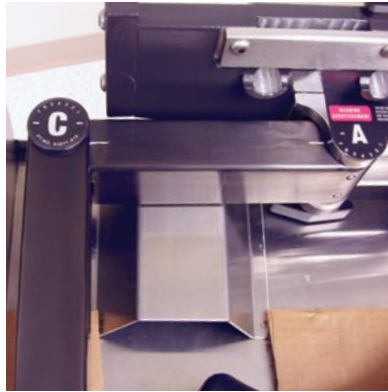

Figure 9 - Abductor bar adjustment indicators A & C



Figure 10 - CORRECT: Rosette joints nested properly



Figure 11 - INCORRECT: Rosette joints not aligned



Figure 12 - Loosen siderail locking knobs

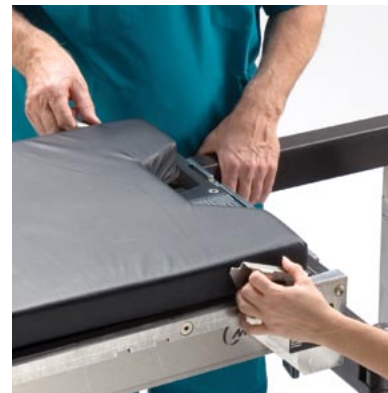

Figure 13 - Hold gravity locks up



Figure 14 - Slide orthopedic extension off of table



Figure 15 - Place extension on top of cart



Figure 16 - Proper storage

Right Hip Pinning Checklist

Bi-lateral Traction

⚠ WARNING - PREVENT POSSIBLE PATIENT OR USER INJURY: Check table and accessories for damage or wear prior to each use. Do not use if any damage is apparent or device cannot be securely tightened.

1. Attach Cmax/3080/3085 SP Orthopedic Extension. Refer to Equipment Instructions, page B.
2. Position and lock abductor bars per diagram.*
3. Insert sacral rest into affected (patient right) side slot of bracket.
4. Place traction accessory clamps on abductor bars.
5. Position carbon fiber traction unit assemblies in the traction accessory clamps and adjust per diagram.
6. Insert patient transfer board.
7. Transfer patient.
8. Add arm supports to unaffected (patient left) side.
9. Insert perineal post and be sure patient is snug against it.
10. Attach lateral brace assembly to affected (right) side (not shown) and be sure patient is snug against it.
11. Secure feet in traction boots and attach them to the traction unit assemblies.
12. Rotate each boot slightly until audible click is heard to ensure boots are securely locked in place.
13. Remove patient transfer board.
14. Raise table to convenient working height for surgeon.
15. Position C-arm as required.
16. Attach surgical drape support and drape table.

*Suggested settings

ACCESSORIES:

- Sacral Rest
- Traction Accessory Clamps (3)
- Traction Unit Assemblies (2)
- Patient Transfer Board (not shown)
- Armboard
- Multi-Posture Armboard
- Clark Sockets (2)
- Perineal Post
- Traction Boots (2)
- Surgical Drape Support
- Lateral Brace Assembly w/Side Rail Locks (not shown)

SUGGESTED PRESSURE MANAGEMENT ACCESSORIES (not shown):

- AQUAGEL Contoured Sacral Protector
- AQUAGEL Contoured Arm Protectors (2)
- AQUAGEL Contoured Head Protector
- AQUAGEL 20" Contoured Table Overlay
- AQUAGEL Orthopedic Boot Pads (2)

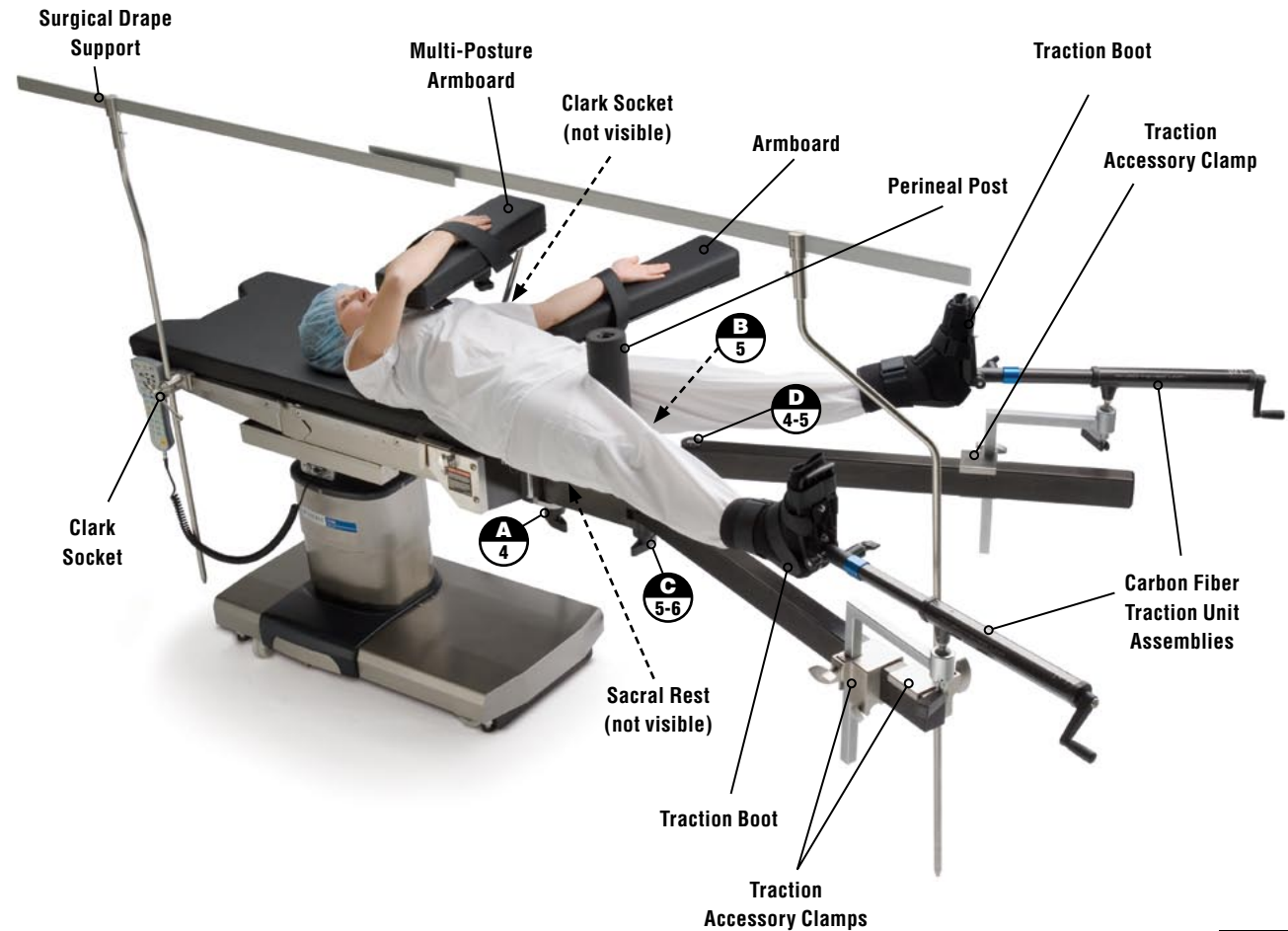

Left Hip Pinning Checklist

Bi-lateral Traction

⚠ WARNING - PREVENT POSSIBLE PATIENT OR USER INJURY: Check table and accessories for damage or wear prior to each use. Do not use if any damage is apparent or device cannot be securely tightened.

1. Attach Cmax/3080/3085 SP Orthopedic Extension. Refer to Equipment Instructions, page B.
2. Position and lock abductor bars per diagram.*
3. Insert sacral rest into affected (patient left) side slot of bracket.
4. Place traction accessory clamps on abductor bars.
5. Position carbon fiber traction unit assemblies in the traction accessory clamps and adjust per diagram.
6. Insert patient transfer board.
7. Transfer patient.
8. Add arm supports to unaffected (patient right) side.
9. Insert perineal post and be sure patient is snug against it.
10. Attach lateral brace assembly (not shown) to affected (left) side and be sure patient is snug against it.
11. Secure feet in traction boots and attach them to the traction unit assemblies.
12. Rotate each boot slightly until audible click is heard to ensure boots are securely locked in place.
13. Remove patient transfer board.
14. Raise table to convenient working height for surgeon.
15. Position C-arm as required.
16. Attach surgical drape support and drape table.

*Suggested settings

ACCESSORIES:

- Sacral Rest
- Traction Accessory Clamps (3)
- Traction Unit Assemblies (2)
- Patient Transfer Board (not shown)
- Armboard
- Multi-Posture Armboard
- Clark Sockets (2)
- Perineal Post
- Lateral Brace Assembly w/Side Rail Locks (not shown)
- Traction Boots (2)
- Surgical Drape Support

SUGGESTED PRESSURE MANAGEMENT ACCESSORIES (not shown):

- AQUAGEL Contoured Sacral Protector
- AQUAGEL Contoured Arm Protectors (2)
- AQUAGEL Contoured Head Protector
- AQUAGEL 20" Contoured Table Overlay
- AQUAGEL Orthopedic Boot Pads (2)

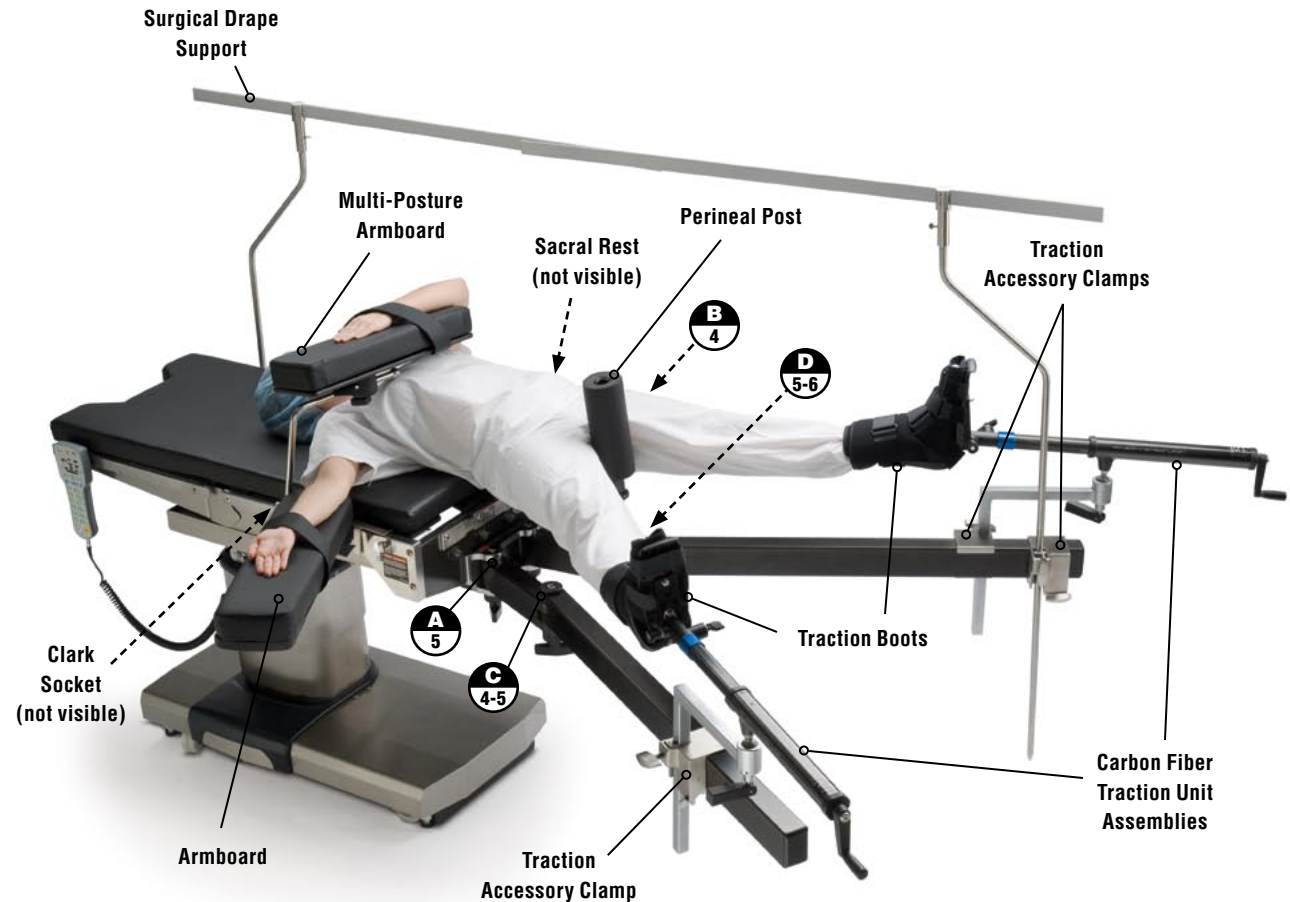

Right Hip Pinning Checklist

Unilateral Traction

⚠ WARNING - PREVENT POSSIBLE PATIENT OR USER INJURY: Check table and accessories for damage or wear prior to each use. Do not use if any damage is apparent or device cannot be securely tightened.

1. Attach Cmax/3080/3085 SP Orthopedic Extension. Refer to Equipment Instructions, page B.
2. Position and lock abductor bars per diagram.*
3. Insert sacral rest into affected (patient right) side slot of bracket.
4. Place traction accessory clamps on affected (right) leg abductor bar.
5. Position carbon fiber traction unit assembly in traction accessory clamp and adjust per diagram.
6. Mount traction accessory clamp on unaffected (left) leg abductor bar and insert universal leg support.
7. Insert patient transfer board.
8. Transfer patient.
9. Add arm supports to unaffected (left) side.
10. Insert perineal post and be sure patient is snug against it.
11. Attach lateral brace assembly (not shown) to affected (right) side and be sure patient is snug against it.
12. Position unaffected (left) leg in universal leg holder.
13. Secure foot in traction boot and attach it to the traction unit assembly.
14. Rotate boot slightly until audible click is heard to ensure boot is securely locked in place.
15. Remove patient transfer board.
16. Raise table to convenient working height for surgeon.
17. Position C-arm as required.
18. Attach surgical drape support and drape table.

*Suggested settings

ACCESSORIES:

- Sacral Rest
- Traction Accessory Clamps (3)
- Traction Unit Assembly
- Patient Transfer Board (not shown)
- Armboard
- Multi-Posture Armboard
- Clark Sockets (2)
- Perineal Post
- Traction Boot
- Universal Legholder
- Surgical Drape Support
- Lateral Brace Assembly w/Side Rail Locks (not shown)

SUGGESTED PRESSURE MANAGEMENT ACCESSORIES (not shown):

- AQUAGEL Contoured Sacral Protector
- AQUAGEL Contoured Arm Protectors (2)
- AQUAGEL Contoured Head Protector
- AQUAGEL 20" Contoured Table Overlay
- AQUAGEL Crutch-style Stirrup Pad
- AQUAGEL Orthopedic Boot Pad

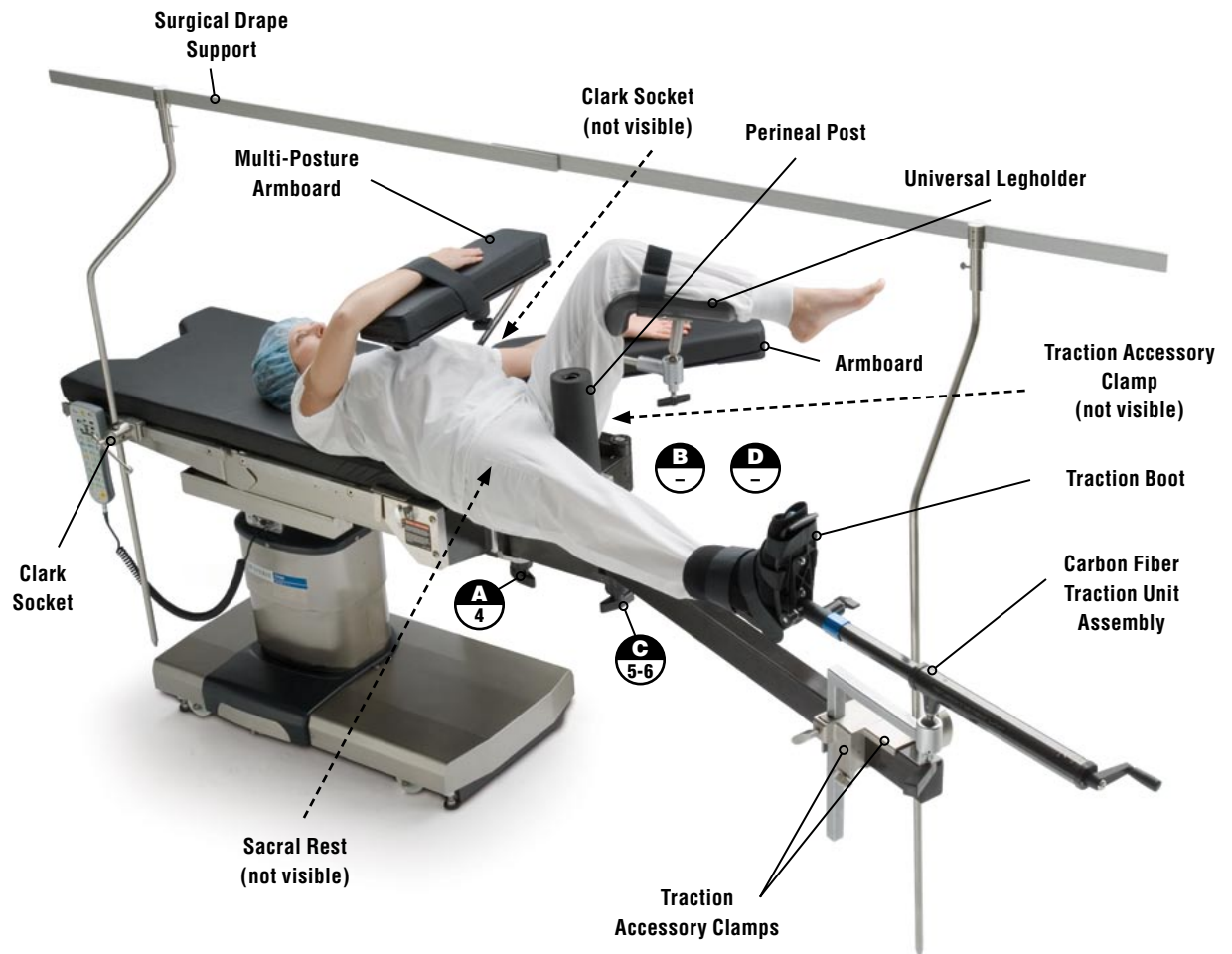

Left Hip Pinning Checklist

Unilateral Traction

⚠ WARNING - PREVENT POSSIBLE PATIENT OR USER INJURY: Check table and accessories for damage or wear prior to each use. Do not use if any damage is apparent or device cannot be securely tightened.

1. Attach Cmax/3080/3085 SP Orthopedic Extension. Refer to Equipment Instructions, page B.
2. Position and lock abductor bars per diagram.*
3. Insert sacral rest into affected (patient left) side slot of bracket.
4. Place traction accessory clamps on affected (patient left) leg abductor bar.
5. Position carbon fiber traction unit assembly in traction accessory clamp and adjust per diagram.
6. Mount traction accessory clamp on unaffected (right) leg abductor bar and insert universal leg support.
7. Insert patient transfer board.
8. Transfer patient.
9. Add arm supports to unaffected (right) side.
10. Insert perineal post and be sure patient is snug against it.
11. Attach lateral brace assembly (not shown) to affected side and be sure patient is snug against it.
12. Position unaffected (right) leg in universal leg holder.
13. Secure foot in traction boot and attach it to the traction unit assembly.
14. Rotate boot slightly until audible click is heard to ensure boot is securely locked in place.
15. Remove patient transfer board.
16. Raise table to convenient working height for surgeon.
17. Position C-arm as required.
18. Attach surgical drape support and drape table.

*Suggested settings

ACCESSORIES:

- Sacral Rest
- Traction Accessory Clamps (3)
- Traction Unit Assembly
- Patient Transfer Board (not shown)
- Armboard
- Multi-Posture Armboard
- Clark Sockets (2)
- Perineal Post
- Traction Boot
- Universal Legholder
- Surgical Drape Support
- Lateral Brace Assembly w/Side Rail Locks (not shown)

SUGGESTED PRESSURE MANAGEMENT ACCESSORIES (not shown):

- AQUAGEL Contoured Sacral Protector
- AQUAGEL Contoured Arm Protectors (2)
- AQUAGEL Contoured Head Protector
- AQUAGEL 20" Contoured Table Overlay
- AQUAGEL Crutch-style Stirrup Pad
- AQUAGEL Orthopedic Boot Pad

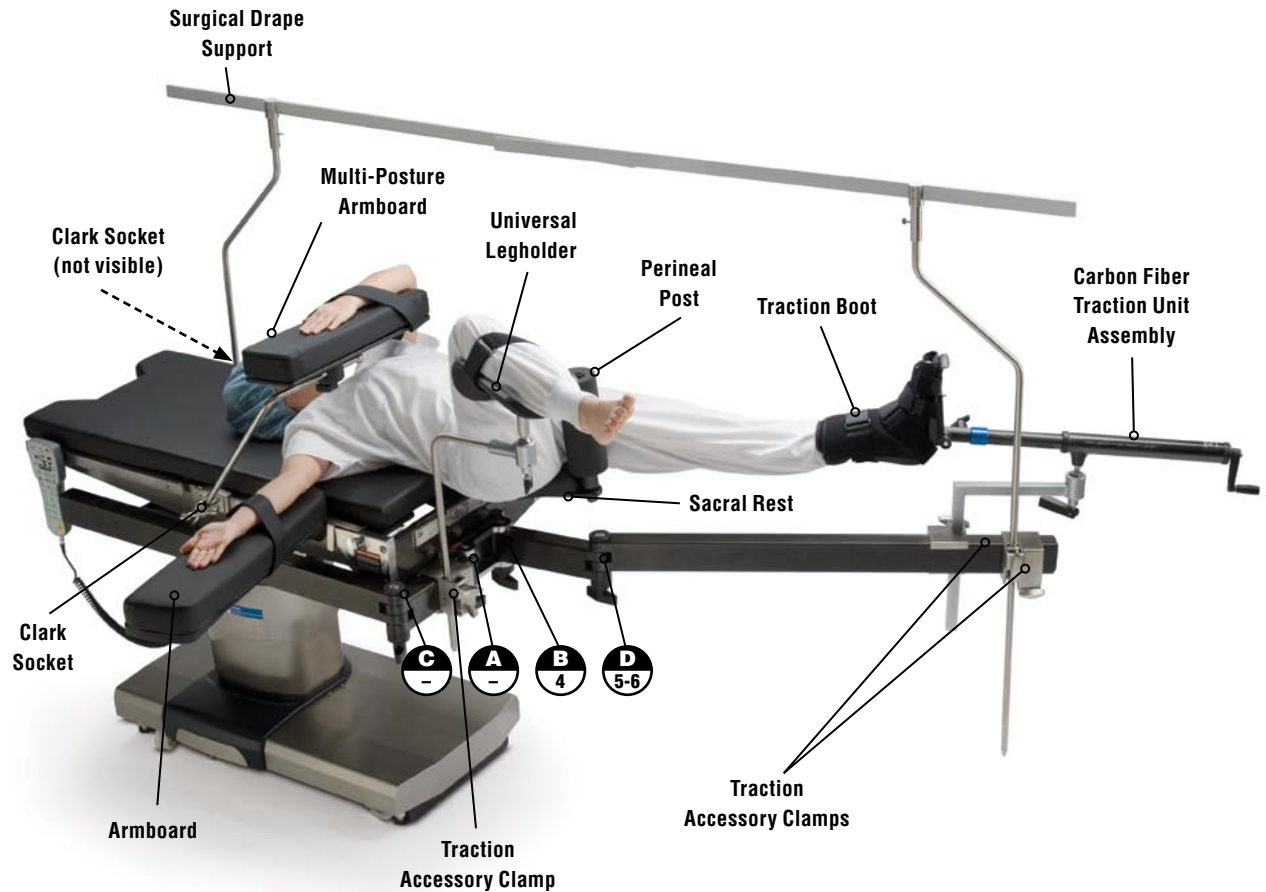

Right IM Nailing Supine Checklist

⚠ WARNING - PREVENT POSSIBLE PATIENT OR USER INJURY: Check table and accessories for damage or wear prior to each use. Do not use if any damage is apparent or device cannot be securely tightened.

1. Attach Cmax/3080/3085 SP Orthopedic Extension. Refer to Equipment Instructions, page B.
2. Position and lock abductor bars per diagram.*
3. Insert sacral rest into affected (patient right) side slot of bracket.
4. Place traction accessory clamp and carbon fiber traction unit assembly on affected (right) leg abductor bar per diagram.
5. Apply traction accessory clamp to unaffected (left) leg abductor bar and insert universal leg holder.
6. Loosen and move abductor bar of affected (right) leg.
7. Insert patient transfer board.
8. Transfer patient.
9. Add arm supports to unaffected (left) side.
10. Insert perineal post and be sure patient is snug against it.
11. Attach lateral brace assembly (not shown) to affected (right) side and be sure patient is snug against it.
12. Position unaffected (left) leg in universal legholder.
13. Support affected (right) leg and remove patient transfer board.
14. Reposition affected (right) leg abductor bar per diagram while supporting affected leg.
15. Secure patient's foot in traction boot and attach it to traction unit assembly.
16. Rotate boot slightly until audible click is heard to ensure boot is securely locked in place.
17. Raise table to convenient working height for surgeon and lateral tilt towards unaffected side.
18. Loosen setting 'C' if surgeon requires abduction of affected femur. This can aid in location and alignment of the fracture.
19. Position C-arm as required.

*Suggested settings

ACCESSORIES:

- Sacral Rest
- Traction Accessory Clamps (2)
- Traction Unit Assembly
- Patient Transfer Board (not shown)
- Armboard
- Multi-Posture Armboard
- Clark Socket
- Perineal Post
- Universal Legholder
- Traction Boot
- Lateral Brace Assembly w/Side Rail Locks (not shown)
- OPTIONAL: Tibial/lateral Countertraction Support (used as popliteal support)

SUGGESTED PRESSURE MANAGEMENT ACCESSORIES (not shown):

- AQUAGEL Contoured Sacral Protector
- AQUAGEL Contoured Arm Protectors (2)
- AQUAGEL Contoured Head Protector
- AQUAGEL 20" Contoured Table Overlay
- AQUAGEL Crutch-style Stirrup Pad
- AQUAGEL Orthopedic Boot Pad

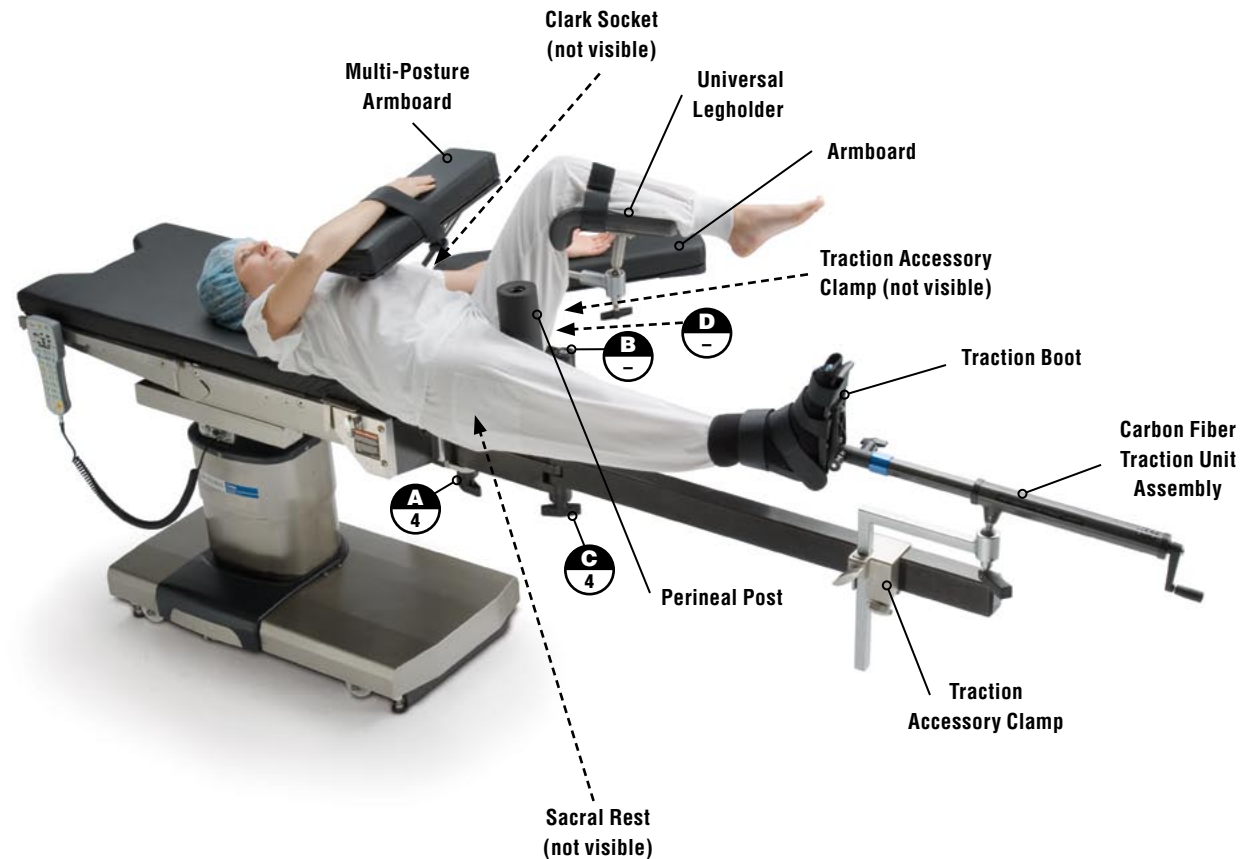

NOTE: If this set-up presents an imaging challenge, try setting patient's right abductor bar to **A/3** and **C/5**.

Left IM Nailing Supine Checklist

⚠ WARNING - PREVENT POSSIBLE PATIENT OR USER INJURY: Check table and accessories for damage or wear prior to each use. Do not use if any damage is apparent or device cannot be securely tightened.

1. Attach Cmax/3080/3085 SP Orthopedic Extension. Refer to Equipment Instructions, page B.
2. Position and lock abductor bars per diagram.*
3. Insert sacral rest into affected (patient left) side slot of bracket.
4. Place traction accessory clamp and carbon fiber traction unit assembly on affected (left) leg abductor bar.
5. Apply traction accessory clamp to unaffected (right) leg abductor bar and insert universal legholder.
6. Loosen and move abductor bar of affected (left) leg.
7. Insert patient transfer board.
8. Transfer patient.
9. Add arm supports to unaffected (right) side.
10. Insert perineal post and be sure patient is snug against it.
11. Attach lateral brace assembly (not shown) to affected (left) side and be sure patient is snug against it.
12. Position unaffected (right) leg in universal legholder.
13. Support affected (left) leg and remove patient transfer board.
14. Reposition affected (left) leg abductor bar per diagram while supporting affected leg.
15. Secure patient's foot in traction boot and attach it to traction unit assembly.
16. Rotate boot slightly until audible click is heard to ensure boot is securely locked in place.
17. Raise table to convenient working height for surgeon and lateral tilt towards unaffected side.
18. Loosen setting 'D' if surgeon requires abduction of affected femur. This can aid in location and alignment of the fracture.
19. Position C-arm as required.

*Suggested settings

ACCESSORIES:

- Sacral Rest
- Traction Accessory Clamps (2)
- Traction Unit Assembly
- Patient Transfer Board
- Armboard
- Multi-Posture Armboard
- Clark Socket
- Perineal Post
- Universal Legholder
- Foot Traction Boot
- Lateral Brace Assembly w/Side Rail Locks (not shown)
- OPTIONAL: Tibial/lateral Countertraction Support (used as popliteal support)

SUGGESTED PRESSURE MANAGEMENT ACCESSORIES (not shown):

- AQUAGEL Contoured Sacral Protector
- AQUAGEL Contoured Arm Protectors (2)
- AQUAGEL Contoured Head Protector
- AQUAGEL 20" Contoured Table Overlay
- AQUAGEL Crutch-style Stirrup Pad
- AQUAGEL Orthopedic Boot Pad

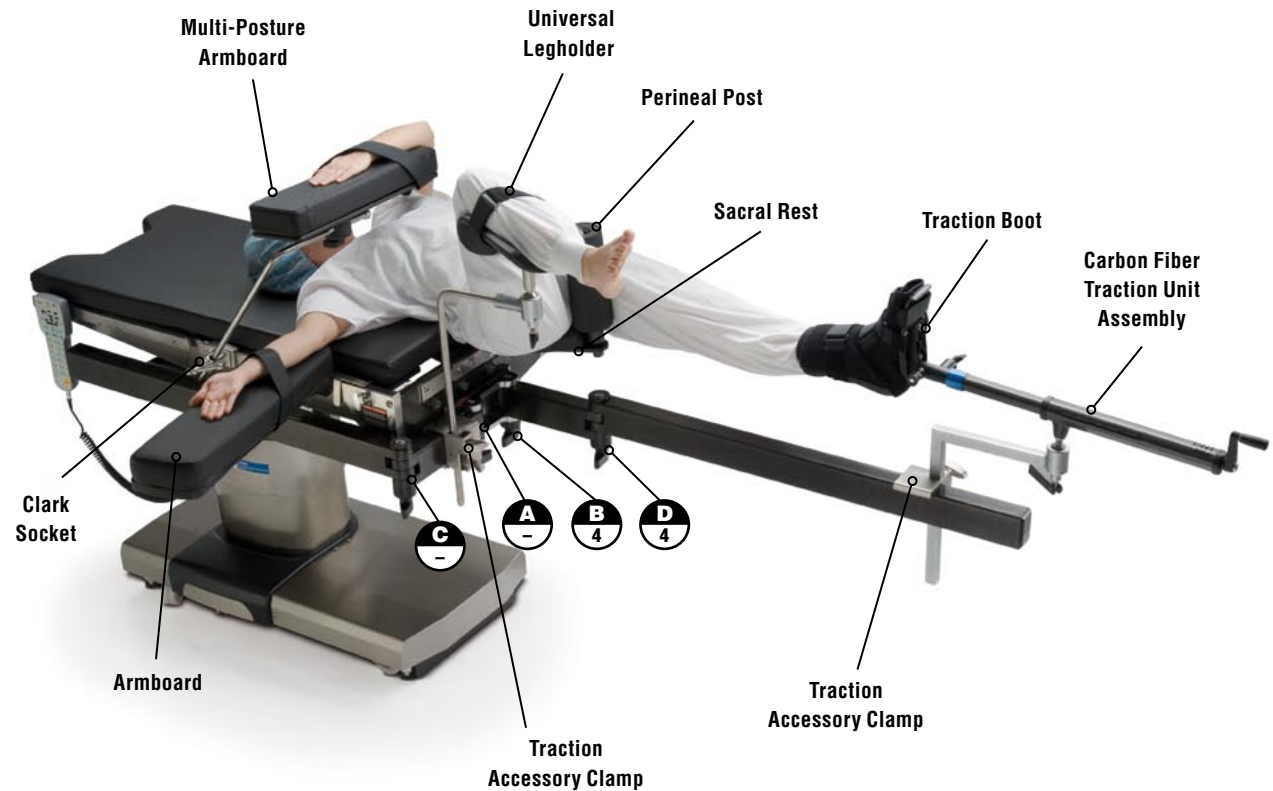

NOTE: If this set-up presents an imaging challenge, try setting patient's left abductor bar to **B/3** and **D/5**.

Right I.M. Nailing-Supine w/Skeletal Traction Checklist

⚠ WARNING - PREVENT POSSIBLE PATIENT OR USER INJURY: Check table and accessories for damage or wear prior to each use. Do not use if any damage is apparent or device cannot be securely tightened.

1. Attach Cmax/3080/3085 SP Orthopedic Extension. Refer to Equipment Instructions, page B.
2. Position and lock abductor bars per diagram.*
3. Insert sacral rest into affected (patient right) side slot of bracket.
4. Place traction accessory clamps and carbon fiber traction unit assembly on affected (right) abductor bar.
5. Insert skeletal traction bow/block into traction unit assembly; rotate slightly until audible click is heard to ensure it is secure.
6. Apply traction accessory clamp on unaffected (left) leg abductor bar and insert universal legholder.
7. Loosen and move affected (right) leg abductor bar.
8. Insert patient transfer board.
9. Transfer patient.
10. Add arm supports to unaffected (left) side.
11. Insert perineal post and be sure patient is snug against it.
12. Attach lateral brace assembly (not shown) to affected (right) side and be sure patient is snug against it.
13. Position unaffected (left) leg in universal legholder.
14. Support affected (right) leg and remove patient transfer board.
15. Reposition affected (right) abductor bar per diagram while supporting affected leg.
16. Place patient's foot in traction boot, attach it to the traction unit assembly and secure.
17. Rotate boot slightly until audible click is heard to ensure boot is securely locked in place.
18. Reposition skeletal traction bow/block as needed and secure to patient's affected (right) leg.
19. Raise table to convenient working height for surgeon and lateral tilt towards unaffected (left) side.
20. Loosen setting 'C' if surgeon requires abduction of affected femur. This can aid in location and alignment of the fracture.
21. Position C-arm as required.

*Suggested settings

ACCESSORIES:

- Armboard
- Skeletal Traction Bow/Block
- Traction Accessory Clamps (3)
- Universal Legholder
- Patient Transfer Board (not shown)
- Lateral Brace Assembly w/Side Rail Locks (not shown)
- Perineal Post
- Sacral Rest
- Multi-Posture Armboard
- Traction Boot
- Clark Socket
- OPTIONAL: Straight Traction Extension
- Traction Unit Assemblies (2)

SUGGESTED PRESSURE MANAGEMENT ACCESSORIES (not shown):

- AQUAGEL Contoured Sacral Protector
- AQUAGEL Contoured Arm Protectors (2)
- AQUAGEL Contoured Head Protector
- AQUAGEL 20" Contoured Table Overlay
- AQUAGEL Crutch-style Stirrup Pad
- AQUAGEL Orthopedic Boot Pad



Left I.M. Nailing-Supine w/Skeletal Traction Checklist

⚠ WARNING - PREVENT POSSIBLE PATIENT OR USER INJURY: Check table and accessories for damage or wear prior to each use. Do not use if any damage is apparent or device cannot be securely tightened.

1. Attach Cmax/3080/3085 SP Orthopedic Extension. Refer to Equipment Instructions, page B.
2. Position and lock abductor bars per diagram.*
3. Insert sacral rest into affected (patient left) side slot of bracket.
4. Place traction accessory clamps and carbon fiber traction unit assembly on affected (left) abductor bar.
5. Insert skeletal traction bow/block into traction unit assembly; rotate slightly until audible click is heard to ensure it is secure.
6. Apply traction accessory clamp on unaffected (right) leg abductor bar and insert universal legholder.
7. Loosen and move affected (left) leg abductor bar.
8. Insert patient transfer board.
9. Transfer patient.
10. Add arm supports to unaffected (right) side.
11. Insert perineal post and be sure patient is snug against it.
12. Attach lateral brace assembly (not shown) to affected (left) side and be sure patient is snug against it.
13. Position unaffected (right) leg in universal legholder.
14. Support affected (left) leg and remove patient transfer board.
15. Reposition affected (left) leg abductor bar per diagram while supporting affected leg.
16. Place patient's foot in traction boot, attach it to the traction unit assembly and secure.
17. Rotate boot slightly until audible click is heard to ensure boot is securely locked in place.
18. Reposition skeletal traction bow/block as needed and secure to patient's affected (left) leg.
19. Raise table to convenient working height for surgeon and lateral tilt towards unaffected (right) side.
20. Loosen setting 'D' if surgeon requires abduction of affected femur. This can aid in location and alignment of the fracture.
21. Position C-arm as required.

*Suggested settings

ACCESSORIES:

- Armboard
- Traction Accessory Clamps (3)
- Patient Transfer Board (not shown)
- Perineal Post
- Multi-Posture Armboard
- Clark Socket
- Traction Unit Assemblies (2)
- Skeletal Traction Bow/Block
- Universal Legholder
- Lateral Brace Assembly w/Side Rail Locks (not shown)
- Sacral Rest
- Traction Boot
- OPTIONAL: Straight Traction Extension

SUGGESTED PRESSURE MANAGEMENT ACCESSORIES (not shown):

- AQUAGEL Contoured Sacral Protector
- AQUAGEL Contoured Arm Protectors (2)
- AQUAGEL Contoured Head Protector
- AQUAGEL 20" Contoured Table Overlay
- AQUAGEL Crutch-style Stirrup Pad
- AQUAGEL Orthopedic Boot Pad

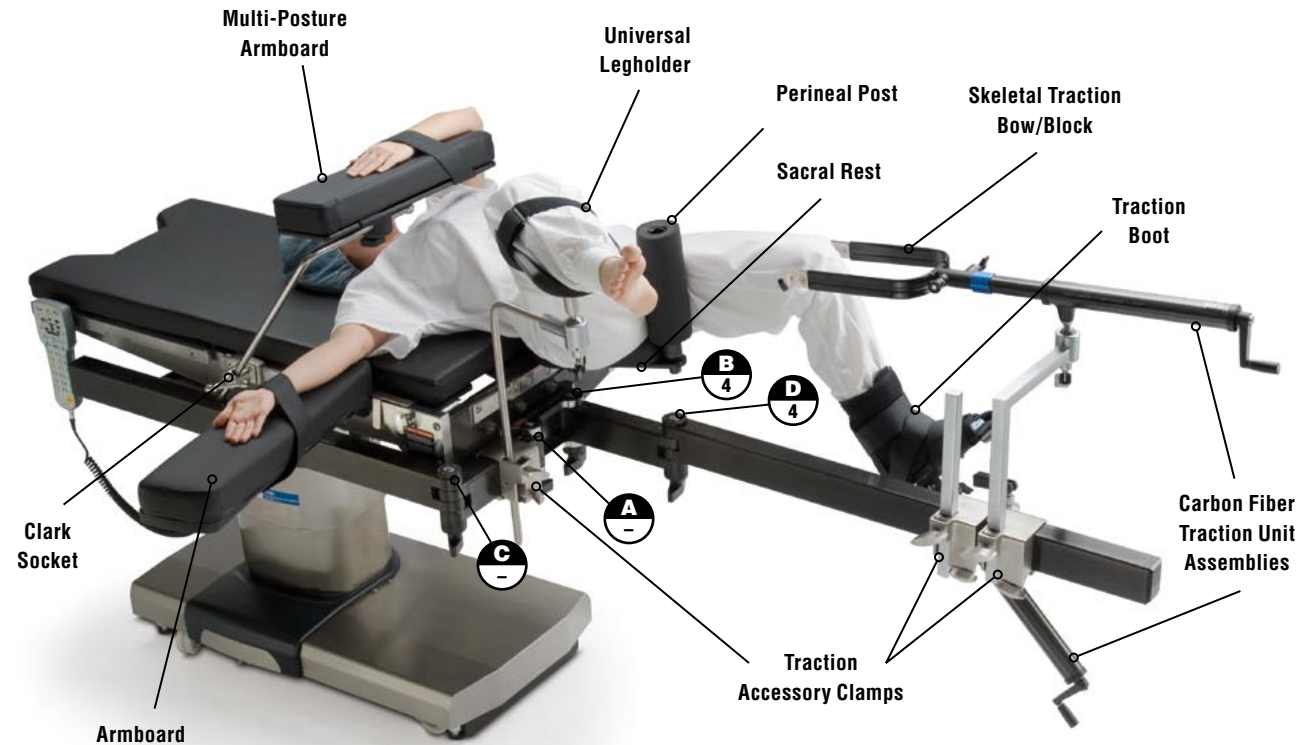

NOTE: Reverse I.M. Nailing can be done by inserting a straight traction extension in the distal traction accessory clamp and attaching the traction unit assembly (as shown in photo, left) for greater knee flexion.

Right I.M. Nailing Lateral Checklist Traditional Setup

⚠ WARNING - PREVENT POSSIBLE PATIENT OR USER INJURY: Check table and accessories for damage or wear prior to each use. Do not use if any damage is apparent or device cannot be securely tightened.

1. Attach Cmax/3080/3085 SP Orthopedic Extension. Refer to Equipment Instructions, page B.
2. Position and lock abductor bars per diagram.*
3. Insert hip rest into affected (patient right) side slot of bracket.
4. Position traction accessory clamps, carbon fiber traction unit assemblies and L-shaped traction extensions per diagram.
5. Insert patient transfer board.
6. Transfer patient onto table (in supine position).
7. After anesthetizing, roll patient onto unaffected (left) side.
8. Add arm supports to unaffected (left) side.
9. Mount tibial/lateral countertraction support into traction accessory clamp on abductor bar on unaffected (left) side of patient and tighten.
10. Supporting the affected (right) leg, rotate the tibial/lateral countertraction support between legs.
11. Adjust the height of the tibial/lateral countertraction support to compensate for patient size and ensure patient is snug against it.
12. Tighten knobs to secure.
13. Insert perineal post on tibial/lateral countertraction support.
14. While supporting legs, remove patient transfer board and reposition abductor bar per diagram.
15. Place patient's feet in traction boots, attach them to traction unit assemblies and secure.
16. Rotate each boot slightly until audible click is heard to ensure boots are securely locked in place.
17. Attach lateral brace assembly (not shown) to the table and be sure it is snug against patient's back.
18. Raise table to convenient working height for surgeon and lateral tilt towards unaffected side.
19. Position C-arm as required.

*Suggested settings

ACCESSORIES:

- Hip Rest
- Traction Accessory Clamps (3)
- L-shaped Traction Extensions (3)
- Traction Unit Assemblies (2)
- Patient Transfer Board (not shown)
- Armboard
- Multi-Posture Armboard
- Clark Socket
- Tibial/lateral Countertraction Support
- Perineal Post
- Lateral Brace Assembly w/Side Rail Locks (not shown)
- Traction Boots (2)

SUGGESTED PRESSURE MANAGEMENT ACCESSORIES (not shown):

- AQUAGEL Contoured Sacral Protector
- AQUAGEL Contoured Arm Protectors (2)
- AQUAGEL Contoured Head Protector
- AQUAGEL 20" Contoured Table Overlay
- AQUAGEL Lateral Positioner
- AQUAGEL Orthopedic Boot Pads (2)

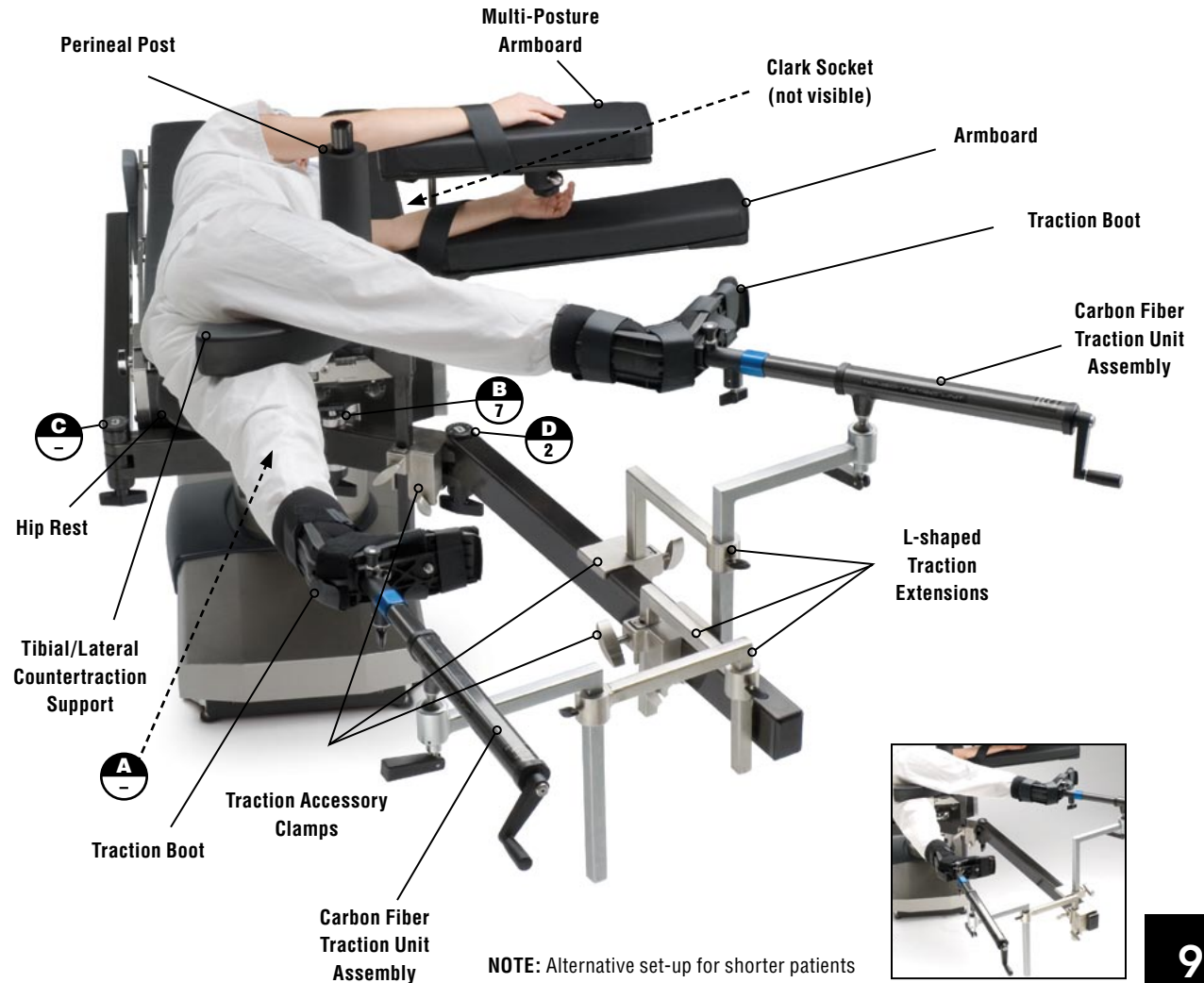

Left I.M. Nailing Lateral Checklist Traditional Setup

⚠ WARNING - PREVENT POSSIBLE PATIENT OR USER INJURY: Check table and accessories for damage or wear prior to each use. Do not use if any damage is apparent or device cannot be securely tightened.

1. Attach Cmax/3080/3085 SP Orthopedic Extension. Refer to Equipment Instructions, page B.
2. Position and lock abductor bars per diagram.*
3. Insert hip rest into affected (patient left) side slot of bracket.
4. Position traction accessory clamps, carbon fiber traction unit assemblies and L-shaped traction extensions per diagram.
5. Insert patient transfer board.
6. Transfer patient onto table (in supine position).
7. After anesthetizing, roll patient onto unaffected (right) side.
8. Add arm supports to unaffected (right) side.
9. Mount tibial/lateral countertraction support into traction accessory clamp on abductor bar on unaffected side of patient and tighten.
10. Supporting the affected (left) leg, rotate the tibial/lateral countertraction support between legs.
11. Adjust the height of the tibial/lateral countertraction support to compensate for patient size and ensure patient is snug against it.
12. Tighten knobs to secure.
13. Insert perineal post on tibial/lateral countertraction support.
14. While supporting legs, remove patient transfer board and reposition abductor bar per diagram.
15. Place patient's feet in traction boots, attach them to traction unit assemblies and secure.
16. Rotate each boot slightly until audible click is heard to ensure boots are securely locked in place.
17. Attach lateral brace assembly (not shown) to the table and be sure it is snug against patient's back.
18. Raise table to convenient working height for surgeon and lateral tilt towards unaffected side.
19. Position C-arm as required.

*Suggested settings

ACCESSORIES:

- Hip Rest
- Traction Accessory Clamps (3)
- L-shaped Traction Extensions (3)
- Traction Unit Assemblies (2)
- Patient Transfer Board (not shown)
- Armboard
- Multi-Posture Armboard
- Clark Socket
- Tibial/lateral Countertraction Support
- Perineal Post
- Lateral Brace Assembly w/Side Rail Locks (not shown)
- Traction Boots (2)

SUGGESTED PRESSURE MANAGEMENT ACCESSORIES (not shown):

- AQUAGEL Contoured Sacral Protector
- AQUAGEL Contoured Arm Protector (2)
- AQUAGEL Contoured Head Protector
- AQUAGEL 20" Contoured Table Overlay
- AQUAGEL Lateral Positioner
- AQUAGEL Orthopedic Boot Pads (2)



Right I.M. Nailing Lateral Checklist Alternate Setup

⚠ WARNING - PREVENT POSSIBLE PATIENT OR USER INJURY: Check table and accessories for damage or wear prior to each use. Do not use if any damage is apparent or device cannot be securely tightened.

1. Attach Cmax/3080/3085 SP Orthopedic Extension. Refer to Equipment Instructions, page B.
2. Position and lock abductor bars per diagram.*
3. Insert hip rest into affected (patient right) side slot of bracket.
4. Position traction accessory clamps, L-shaped traction extension and carbon fiber traction unit assemblies per diagram.
5. Insert patient transfer board.
6. Transfer patient onto table (in supine position).
7. After anesthetizing, roll patient onto unaffected (left) side.
8. Add arm supports to unaffected (left) side.
9. Mount tibial/lateral countertraction support into traction accessory clamp on abductor bar on unaffected (left) side of patient and tighten.
10. Supporting the affected (right) leg, rotate the tibial/lateral countertraction support between legs.
11. Adjust the height of the tibial/lateral countertraction support to compensate for patient size and ensure patient is snug against it.
12. Tighten knobs to secure.
13. Insert perineal post on tibial/lateral countertraction support.
14. While supporting legs, remove patient transfer board and reposition abductor bar per diagram.
15. Place patient's feet in traction boots, attach them to traction unit assemblies and secure.
16. Rotate each boot slightly until audible click is heard to ensure boots are securely locked in place.
17. Attach lateral brace assembly (not shown) to the table and be sure it is snug against patient's back.
18. Raise table to convenient working height for surgeon and lateral tilt towards unaffected side.
19. Position C-arm as required.

*Suggested settings

ACCESSORIES:

- Hip Rest
- Traction Accessory Clamps (3)
- L-shaped Traction Extension
- Traction Unit Assemblies (2)
- Patient Transfer Board (not shown)
- Armboard
- Multi-Posture Armboard
- Clark Socket
- Tibial/lateral Countertraction Support
- Perineal Post
- Lateral Brace Assembly w/Side Rail Locks (not shown)
- Traction Boots (2)

SUGGESTED PRESSURE MANAGEMENT ACCESSORIES (not shown):

- AQUAGEL Contoured Sacral Protector
- AQUAGEL Contoured Arm Protectors (2)
- AQUAGEL Contoured Head Protector
- AQUAGEL 20" Contoured Table Overlay
- AQUAGEL Lateral Positioner
- AQUAGEL Orthopedic Boot Pads (2)

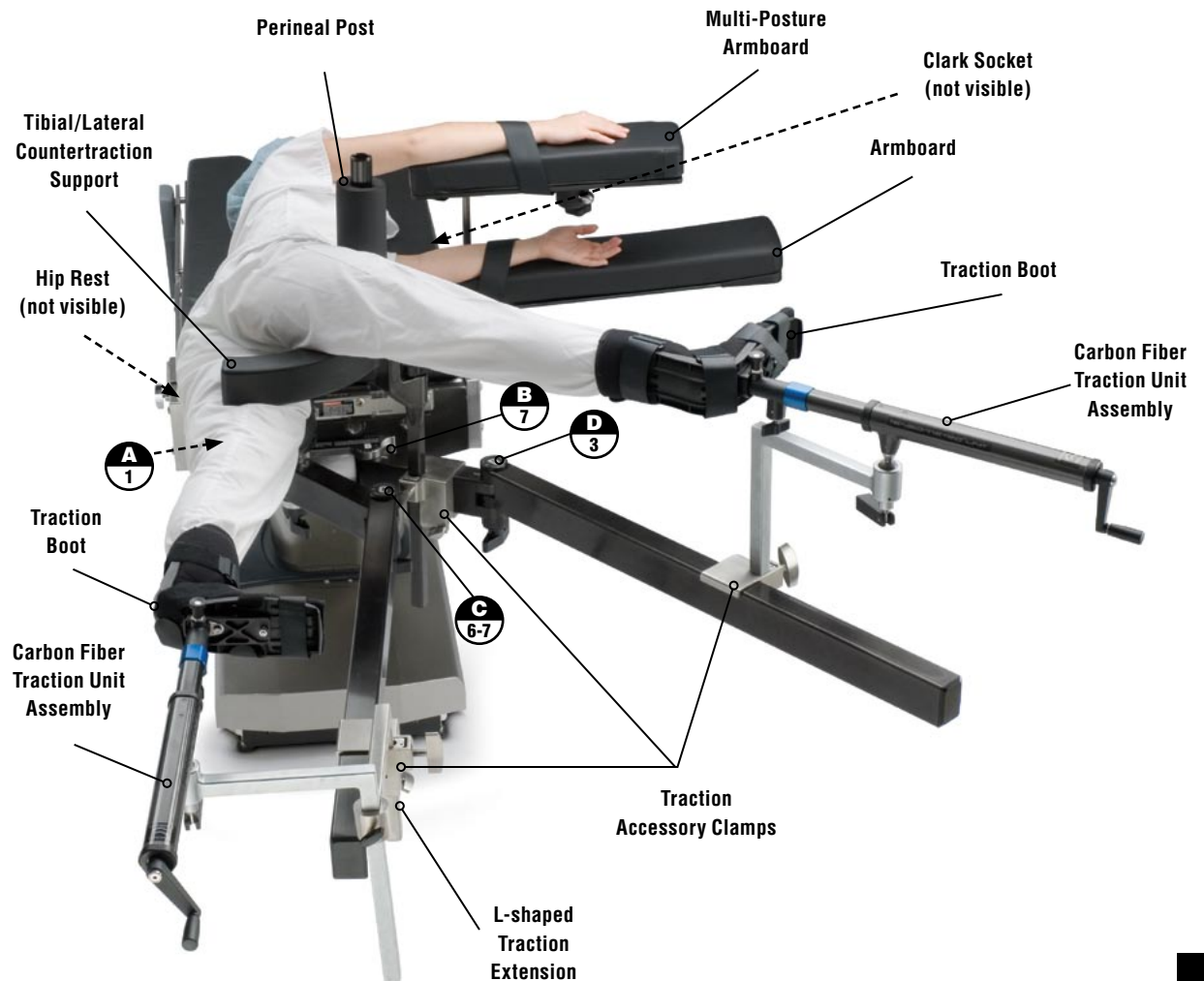

Left I.M. Nailing Lateral Checklist Alternate Setup

⚠ WARNING - PREVENT POSSIBLE PATIENT OR USER INJURY: Check table and accessories for damage or wear prior to each use. Do not use if any damage is apparent or device cannot be securely tightened.

1. Attach Cmax/3080/3085 SP Orthopedic Extension. Refer to Equipment Instructions, page B.
2. Position and lock abductor bars per diagram.*
3. Insert hip rest into affected (patient left) side slot of bracket.
4. Position traction accessory clamps, L-shaped traction extension and carbon fiber traction unit assemblies per diagram.
5. Insert patient transfer board.
6. Transfer patient onto table (in supine position).
7. After anesthetizing, roll patient onto unaffected (right) side.
8. Add arm supports to unaffected (right) side.
9. Mount tibial/lateral countertraction support into traction accessory clamp on abductor bar on unaffected (right) side of patient and tighten.
10. Supporting the affected (left) leg, rotate the tibial/lateral countertraction support between legs.
11. Adjust the height of the tibial/lateral countertraction support to compensate for patient size and ensure patient is snug against it.
12. Tighten knobs to secure.
13. Insert perineal post on tibial/lateral countertraction support.
14. While supporting legs, remove patient transfer board and reposition abductor bar per diagram.
15. Place patient's feet in traction boots, attach them to traction unit assembly and secure.
16. Rotate each boot slightly until audible click is heard to ensure boots are securely locked in place.
17. Attach lateral brace assembly (not shown) to the table and be sure it is snug against patient's back.
18. Raise table to convenient working height for surgeon and lateral tilt towards unaffected side.
19. Position C-arm as required.

*Suggested settings

ACCESSORIES:

- Hip Rest
- Traction Accessory Clamps (3)
- L-shaped Traction Extension
- Traction Unit Assemblies (2)
- Patient Transfer Board (not shown)
- Armboard
- Multi-Posture Armboard
- Clark Socket
- Tibial/lateral Countertraction Support
- Perineal Post
- Lateral Brace Assembly w/Side Rail Locks (not shown)
- Traction Boots (2)

SUGGESTED PRESSURE MANAGEMENT ACCESSORIES (not shown):

- AQUAGEL Contoured Sacral Protector
- AQUAGEL Contoured Arm Protectors (2)
- AQUAGEL Contoured Head Protector
- AQUAGEL 20" Contoured Table Overlay
- AQUAGEL Lateral Positioner
- AQUAGEL Orthopedic Boot Pads (2)

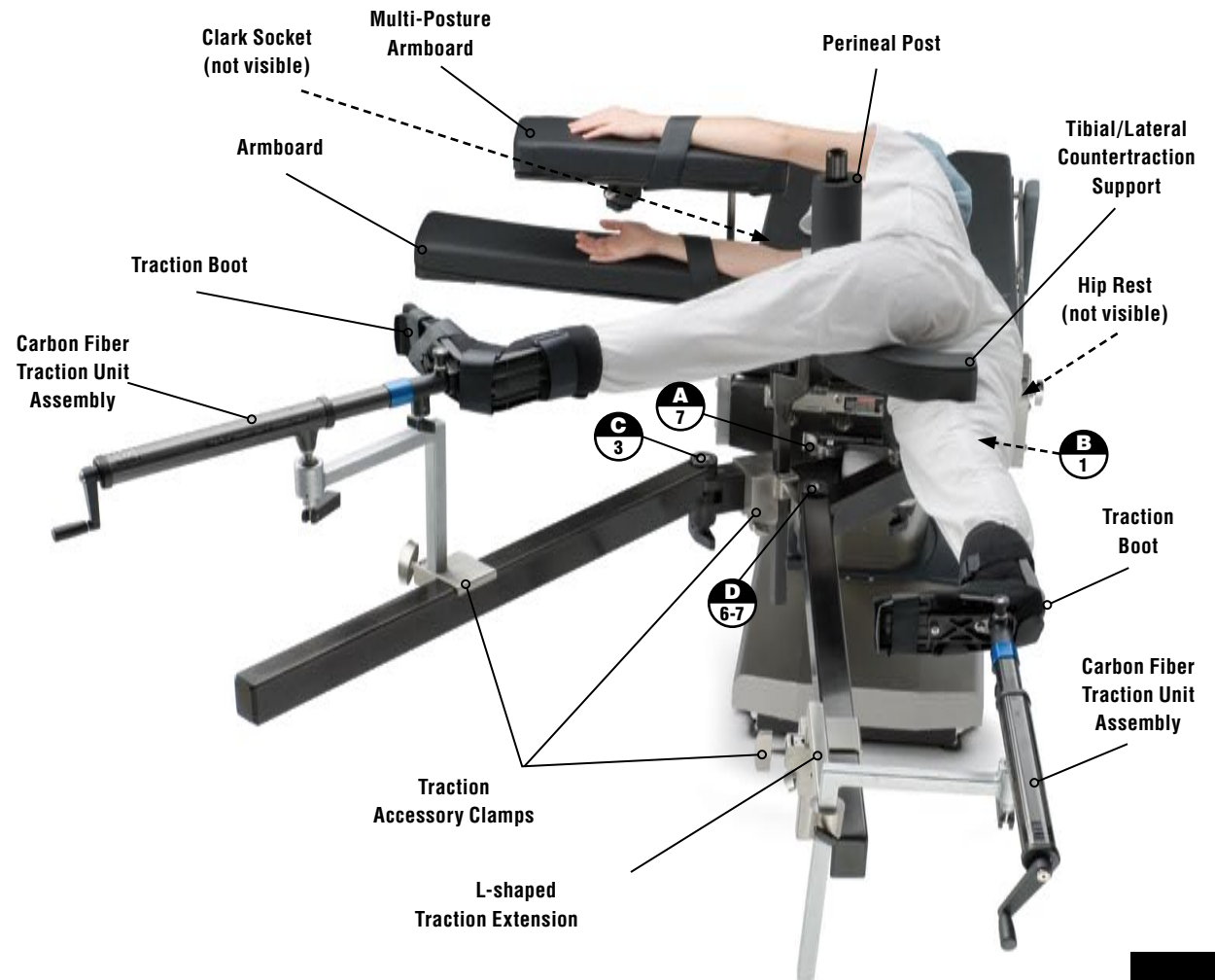

Right I.M. Nailing Lateral Checklist w/Skeletal Traction Traditional Setup

⚠ WARNING - PREVENT POSSIBLE PATIENT OR USER INJURY: Check table and accessories for damage or wear prior to each use. Do not use if any damage is apparent or device cannot be securely tightened.

1. Attach Cmax/3080/3085 SP Orthopedic Extension. Refer to Equipment Instructions, page B.
2. Position and lock abductor bars per diagram.*
3. Insert hip rest into affected (patient right) side slot of bracket.
4. Position traction accessory clamps, L-shaped traction extensions and carbon fiber traction unit assemblies per diagram.
5. Insert traction bow/block into traction unit assembly; rotate slightly until audible click is heard to ensure it is secure.
6. Insert patient transfer board.
7. Transfer patient onto table (in supine position).
8. After anesthetizing, roll patient onto unaffected (left) side.
9. Mount tibial/lateral countertraction support into traction accessory clamp on abductor bar on unaffected (left) side of patient and tighten.
10. Supporting the affected (right) leg, rotate the tibial/lateral countertraction support between legs.
11. Adjust the height of the tibial/lateral countertraction support to compensate for patient size and ensure patient is snug against it.
12. Tighten knobs to secure.
13. Insert perineal post on tibial/lateral countertraction support.
14. Add arm supports to unaffected (left) side.
15. While supporting legs, remove patient transfer board.
16. Secure patient's unaffected (left) leg in traction boot and attach to traction unit assembly.
17. Rotate boot slightly until audible click is heard to ensure boot is securely locked in place.
18. Secure patient's affected (right) leg in skeletal traction bow/block and rest foot on Mayo stand (not shown).
19. Attach lateral brace assembly (not shown) to the table and be sure it is snug against patient's back.
20. Raise table to convenient working height for surgeon and lateral tilt towards unaffected side.
21. Position C-arm as required.

*Suggested settings

ACCESSORIES:

- Hip Rest
- Traction Accessory Clamps (3)
- Traction Unit Assemblies (2)
- L-shaped Traction Extensions (2)
- Skeletal Traction Bow/Block
- Patient Transfer Board (not shown)
- Armboard
- Multi-Posture Armboard
- Clark Socket
- Tibial/lateral Countertraction Support
- Perineal Post
- Traction Boot
- Lateral Brace Assembly w/Side Rail Locks (not shown)
- Mayo stand (not shown, not available through STERIS Corporation)

SUGGESTED PRESSURE MANAGEMENT ACCESSORIES (not shown):

- AQUAGEL Contoured Sacral Protector
- AQUAGEL Contoured Arm Protectors (2)
- AQUAGEL Contoured Head Protector
- AQUAGEL 20" Contoured Table Overlay
- AQUAGEL Lateral Positioner
- AQUAGEL Orthopedic Boot Pad



Left I.M. Nailing Lateral Checklist w/Skeletal Traction Traditional Setup

⚠ WARNING - PREVENT POSSIBLE PATIENT OR USER INJURY: Check table and accessories for damage or wear prior to each use. Do not use if any damage is apparent or device cannot be securely tightened.

1. Attach Cmax/3080/3085 SP Orthopedic Extension. Refer to Equipment Instructions, page B.
2. Position and lock abductor bars per diagram.*
3. Insert hip rest into affected (patient left) side slot of bracket.
4. Position traction accessory clamps, L-shaped traction extensions and carbon fiber traction unit assemblies per diagram.
5. Insert traction bow/block into traction unit assembly; rotate slightly until audible click is heard to ensure it is secure.
6. Insert patient transfer board.
7. Transfer patient onto table (in supine position).
8. After anesthetizing, roll patient onto unaffected (right) side.
9. Mount tibial/lateral countertraction support into traction accessory clamp on abductor bar on unaffected (right) side of patient and tighten.
10. Supporting the affected (left) leg, rotate the tibial/lateral countertraction support between legs.
11. Adjust the height of the tibial/lateral countertraction support to compensate for patient size and ensure patient is snug against it.
12. Tighten knobs to secure.
13. Insert perineal post on tibial/lateral countertraction support.
14. Add arm supports to unaffected (right) side.
15. While supporting legs, remove patient transfer board.
16. Secure patient's unaffected (right) leg in traction boot and attach to traction unit assembly.
17. Rotate boot slightly until audible click is heard to ensure boot is securely locked in place.
18. Secure patient's affected (left) leg in skeletal traction bow/block and rest foot on Mayo stand (not shown).
19. Attach lateral brace assembly (not shown) to the table and be sure it is snug against patient's back.
20. Raise table to convenient working height for surgeon and lateral tilt towards unaffected side.
21. Position C-arm as required.

*Suggested settings

ACCESSORIES:

- Hip Rest
- Traction Accessory Clamps (3)
- Traction Unit Assemblies (2)
- L-shaped Traction Extensions (2)
- Skeletal Traction Bow/Block
- Patient Transfer Board (not shown)
- Armboard
- Multi-Posture Armboard
- Clark Socket
- Tibial/lateral Countertraction Support
- Perineal Post
- Traction Boot
- Lateral Brace Assembly w/Side Rail Locks (not shown)
- Mayo stand (not shown, not available through STERIS Corporation)

SUGGESTED PRESSURE MANAGEMENT ACCESSORIES (not shown):

- AQUAGEL Contoured Sacral Protector
- AQUAGEL Contoured Arm Protectors (2)
- AQUAGEL Contoured Head Protector
- AQUAGEL 20" Contoured Table Overlay
- AQUAGEL Lateral Positioner
- AQUAGEL Orthopedic Boot Pad

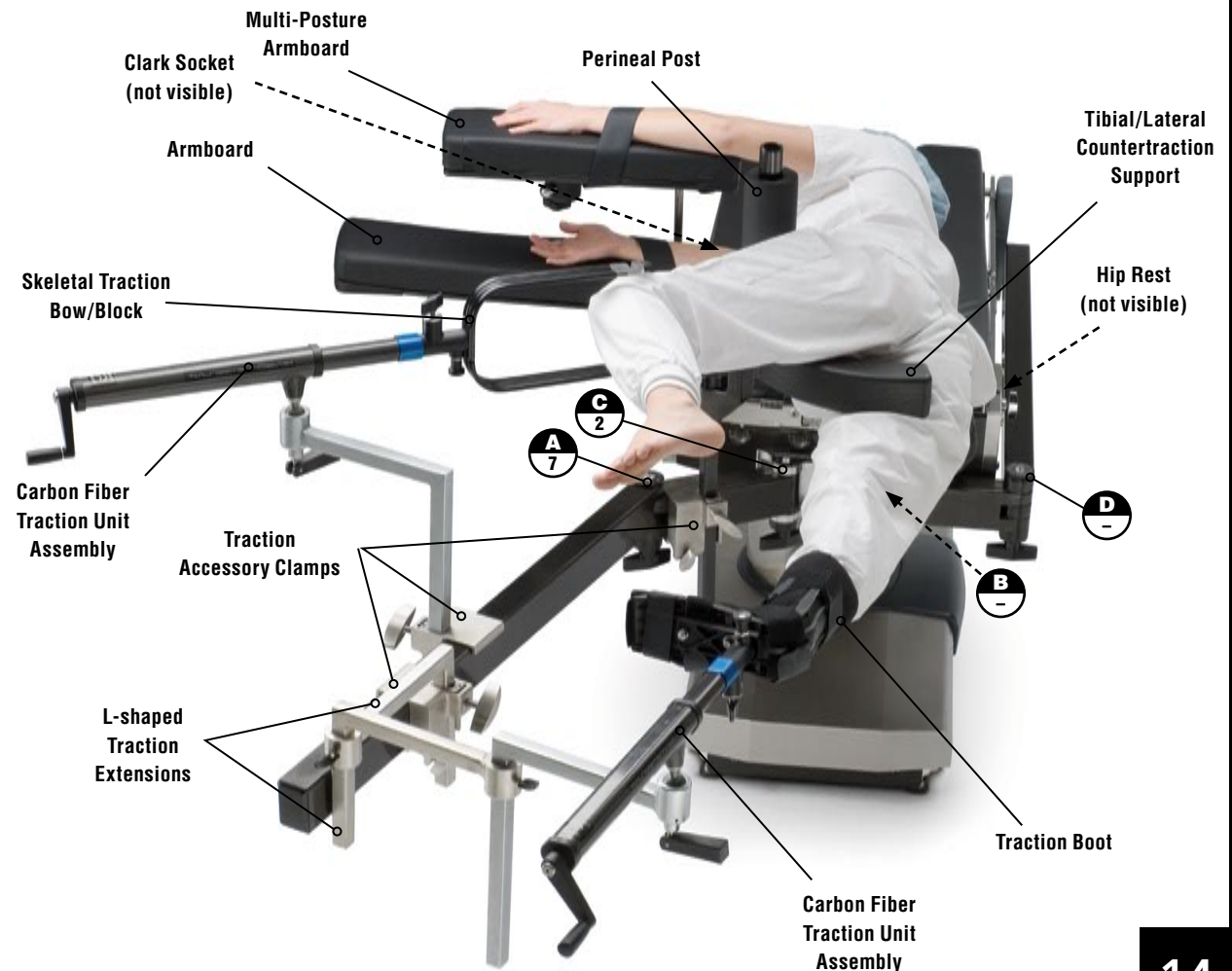

Right I.M. Nailing Lateral Checklist w/Skeletal Traction Alternate Setup

⚠ WARNING - PREVENT POSSIBLE PATIENT OR USER INJURY: Check table and accessories for damage or wear prior to each use. Do not use if any damage is apparent or device cannot be securely tightened.

1. Attach Cmax/3080/3085 SP Orthopedic Extension. Refer to Equipment Instructions, page B.
2. Position and lock abductor bars per diagram.*
3. Insert hip rest into affected (patient right) side slot of bracket.
4. Position traction accessory clamps, L-shaped traction extension and carbon fiber traction unit assemblies per diagram.
5. Insert traction bow/block into traction unit assembly; rotate slightly until audible click is heard to ensure it is secure.
6. Insert patient transfer board.
7. Transfer patient onto table (in supine position).
8. After anesthetizing, roll patient onto unaffected (left) side.
9. Mount tibial/lateral countertraction support into traction accessory clamp on abductor bar on unaffected (left) side of patient and tighten.
10. Supporting the affected (right) leg, rotate the tibial/lateral countertraction support between legs.
11. Adjust the height of the tibial/lateral countertraction support to compensate for patient size and ensure patient is snug against it.
12. Tighten knobs to secure.
13. Insert perineal post on tibial/lateral countertraction support.
14. Add arm supports to unaffected (left) side.
15. While supporting legs, remove patient transfer board.
16. Secure patient's unaffected (left) foot in traction boot and attach to traction unit assembly.
17. Rotate boot slightly until audible click is heard to ensure boot is securely locked in place.
18. Secure patient's affected (right) leg in skeletal traction bow/block and rest foot on Mayo stand (not shown).
19. Attach lateral brace assembly (not shown) to the table and be sure it is snug against patient's back.
20. Raise table to convenient working height for surgeon.
21. Position C-arm as required.

*Suggested settings

ACCESSORIES:

- Hip Rest
- Traction Accessory Clamps (3)
- L-shaped Traction Extension
- Traction Unit Assemblies (2)
- Skeletal Traction Bow/Block
- Patient Transfer Board (not shown)
- Armboard
- Multi-Posture Armboard
- Clark Socket
- Tibial/lateral Countertraction Support
- Perineal Post
- Traction Boot
- Mayo stand (not shown, not available through STERIS Corporation)
- Lateral Brace Assembly w/Side Rail Locks (not shown)

SUGGESTED PRESSURE MANAGEMENT ACCESSORIES (not shown):

- AQUAGEL Contoured Sacral Protector
- AQUAGEL Contoured Arm Protectors (2)
- AQUAGEL Contoured Head Protector
- AQUAGEL 20" Contoured Table Overlay
- AQUAGEL Lateral Positioner
- AQUAGEL Orthopedic Boot Pad



Left I.M. Nailing Lateral Checklist w/Skeletal Traction Alternate Setup

⚠ WARNING - PREVENT POSSIBLE PATIENT OR USER INJURY: Check table and accessories for damage or wear prior to each use. Do not use if any damage is apparent or device cannot be securely tightened.

1. Attach Cmax/3080/3085 SP Orthopedic Extension. Refer to Equipment Instructions, page B.
2. Position and lock abductor bars per diagram.*
3. Insert hip rest into affected (patient left) side slot of bracket.
4. Position traction accessory clamps, L-shaped traction extension and carbon filter traction unit assemblies per diagram.
5. Insert traction bow/block into traction unit assembly; rotate slightly until audible click is heard to ensure it is secure.
6. Insert patient transfer board.
7. Transfer patient onto table (in supine position).
8. After anesthetizing, roll patient onto unaffected (right) side.
9. Mount tibial/lateral countertraction support into traction accessory clamp on abductor bar on unaffected (right) side of patient and tighten.
10. Supporting the affected (left) leg, rotate the tibial/lateral countertraction support between legs.
11. Adjust the height of the tibial/lateral countertraction support to compensate for patient size and ensure patient is snug against it.
12. Tighten knobs to secure.
13. Insert perineal post on tibial/lateral countertraction support.
14. Add arm supports to unaffected (right) side.
15. While supporting legs, remove patient transfer board.
16. Secure patient's unaffected (right) foot in traction boot and attach to traction unit assembly.
17. Rotate boot slightly until audible click is heard to ensure boot is securely locked in place.
18. Secure patient's affected (left) leg in skeletal traction bow/block and rest foot on Mayo stand (not shown).
19. Attach lateral brace assembly (not shown) to the table and be sure it is snug against patient's back.
20. Raise table to convenient working height for surgeon.
21. Position C-arm as required.

*Suggested settings

ACCESSORIES:

- Hip Rest
- Traction Accessory Clamps (3)
- L-shaped Traction Extension
- Traction Unit Assemblies (2)
- Skeletal Traction Bow/Block
- Patient Transfer Board (not shown)
- Armboard
- Multi-Posture Armboard
- Clark Socket
- Tibial/Lateral Countertraction Support
- Perineal Post
- Traction Boots
- Mayo stand (not shown, not available through STERIS Corporation)
- Lateral Brace Assembly w/Side Rail Locks (not shown)

SUGGESTED PRESSURE MANAGEMENT ACCESSORIES (not shown):

- AQUAGEL Contoured Sacral Protector
- AQUAGEL Contoured Arm Protectors (2)
- AQUAGEL Contoured Head Protector
- AQUAGEL 20" Contoured Table Overlay
- AQUAGEL Lateral Positioner
- AQUAGEL Orthopedic Boot Pad

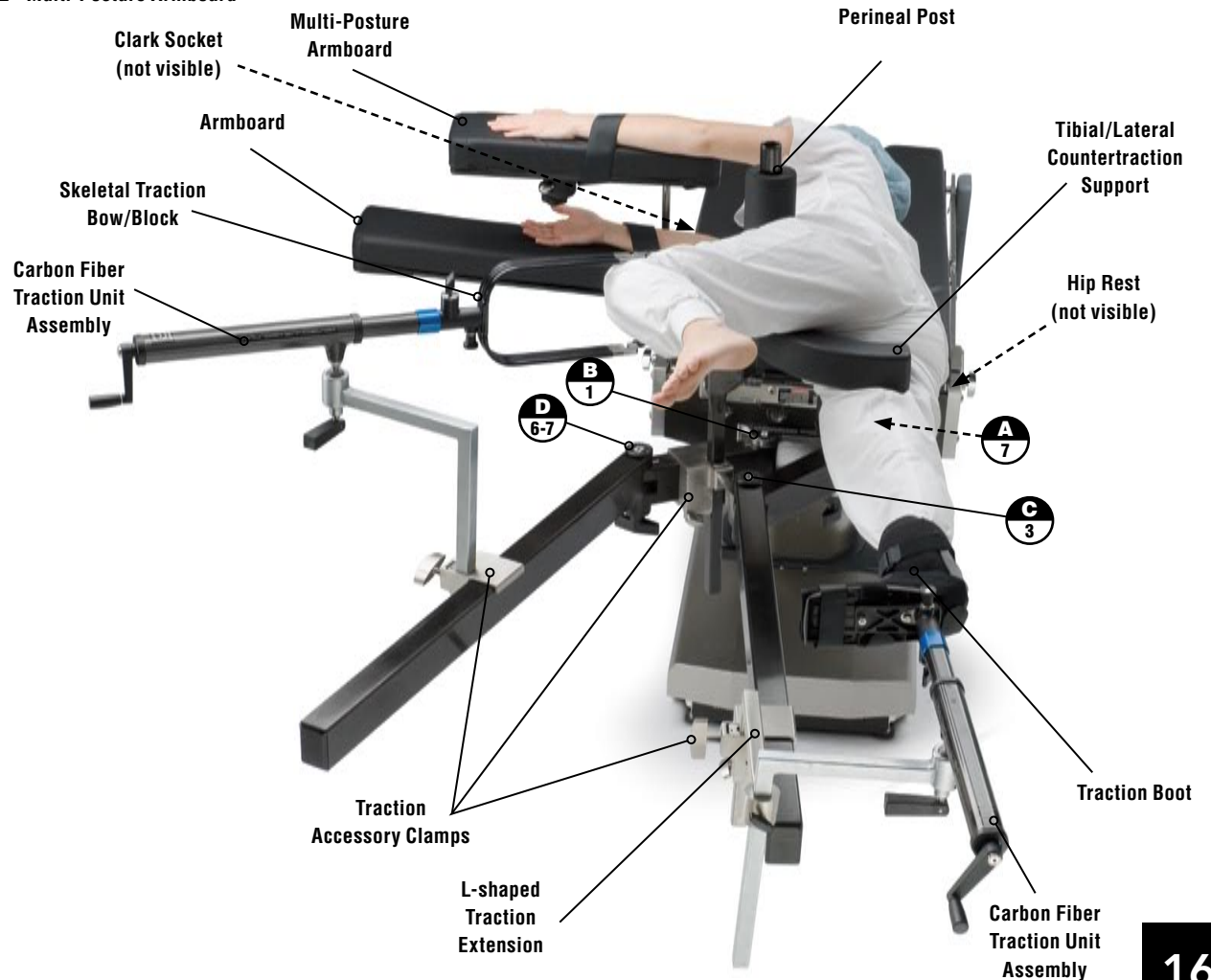

Right Tibia/Fibula Checklist

⚠ WARNING - PREVENT POSSIBLE PATIENT OR USER INJURY: Check table and accessories for damage or wear prior to each use. Do not use if any damage is apparent or device cannot be securely tightened.

1. Attach Cmax/3080/3085 SP Orthopedic Extension. Refer to Equipment Instructions, page B.
2. Position and lock abductor bars per diagram.*
3. Insert sacral rest into affected (patient right) side slot of bracket.
4. Position traction accessory clamps, straight traction extension, carbon fiber traction unit assemblies and universal legholder per diagram.
5. Insert patient transfer board.
6. Transfer patient onto table (supine).
7. Add arm supports to unaffected (left) side.
8. Insert perineal post, making sure patient is snug against it.
9. Position unaffected (left) leg in universal legholder.
10. Support affected (right) leg, and remove patient transfer board.
11. Reposition affected (right) leg abductor bar per diagram while supporting affected leg.
12. Mount tibial/lateral countertraction support into accessory clamp on abductor bar on affected (right) side and tighten.
13. Place affected (right) leg on J-bar of tibial/lateral countertraction support.
14. Adjust tibial/lateral countertraction support to ensure patient is securely supported by it.
15. Attach lateral brace assembly (not shown) to affected (right) side and be sure patient is snug against it.
16. Secure patient's foot in traction boot and attach to traction unit assembly.
17. Rotate boot slightly until audible click is heard to ensure boot is securely locked in place.
18. Raise table to convenient working height for surgeon.
19. Position C-arm as required.

*Suggested settings

ACCESSORIES:

- Sacral Rest
- Traction Accessory Clamps (3)
- Straight Traction Extension
- Traction Unit Assembly
- Patient Transfer Board (not shown)
- Armboard
- Multi-Posture Armboard
- Clark Socket
- Perineal Post
- Universal Legholder
- Tibial/lateral Countertraction Support
- Lateral Brace Assembly w/Side Rail Locks (not shown)
- Traction Boot

SUGGESTED PRESSURE MANAGEMENT ACCESSORIES (not shown):

- AQUAGEL Contoured Sacral Protector
- AQUAGEL Contoured Arm Protectors (2)
- AQUAGEL Contoured Head Protector
- AQUAGEL 20" Contoured Table Overlay
- AQUAGEL Crutch-style Stirrup Pad
- AQUAGEL Orthopedic Boot Pad



Left Tibia/Fibula Checklist

⚠ WARNING - PREVENT POSSIBLE PATIENT OR USER INJURY: Check table and accessories for damage or wear prior to each use. Do not use if any damage is apparent or device cannot be securely tightened.

1. Attach Cmax/3080/3085 SP Orthopedic Extension. Refer to Equipment Instructions, page B.
2. Position and lock abductor bars per diagram.*
3. Insert sacral rest into affected (patient left) side slot of bracket.
4. Position traction accessory clamps, straight traction extension, traction unit assemblies and universal legholder per diagram.
5. Insert patient transfer board.
6. Transfer patient onto table (supine).
7. Add arm supports to unaffected (right) side.
8. Insert perineal post, making sure patient is snug against it.
9. Position unaffected (right) leg in universal legholder.
10. Support affected (left) leg, and remove patient transfer board.
11. Reposition affected (left) leg abductor bar per diagram while supporting affected leg.
12. Mount tibial/lateral countertraction support into accessory clamp on abductor bar on affected (left) side and tighten.
13. Place affected (left) leg on J-bar of tibial/lateral countertraction support.
14. Adjust tibial/lateral countertraction support to ensure patient is securely supported by it.
15. Attach lateral brace assembly (not shown) to affected (left) side and be sure patient is snug against it.
16. Secure patient's foot in traction boot and attach to traction unit assembly.
17. Rotate boot slightly until audible click is heard to ensure boot is securely locked in place.
18. Raise table to convenient working height for surgeon.
19. Position C-arm as required.

*Suggested settings

ACCESSORIES:

- Sacral Rest
- Traction Accessory Clamps (3)
- Straight Traction Extension
- Traction Unit Assembly
- Patient Transfer Board (not shown)
- Armboard
- Multi-Posture Armboard
- Clark Socket
- Perineal Post
- Universal Legholder
- Tibial/lateral Countertraction Support
- Lateral Brace Assembly w/Side Rail Locks (not shown)
- Traction Boot

SUGGESTED PRESSURE MANAGEMENT ACCESSORIES (not shown):

- AQUAGEL Contoured Sacral Protector
- AQUAGEL Contoured Arm Protectors (2)
- AQUAGEL Contoured Head Protector
- AQUAGEL 20" Contoured Table Overlay
- AQUAGEL Crutch-style Stirrup Pad
- AQUAGEL Orthopedic Boot Pad



Accessories



Orthopedic Extension Accessory Package (BF806) includes the following items:

- Abductor Bar System
- Accessory Cart
- Wedge-shaped Sacral Rest with pad (adult)
- Perineal Post with pad (adult)
- Traction Boots (pair, adult)
- Traction Accessory Clamps (2)
- Carbon Fiber Traction Unit Assemblies (2)
- L-shaped Traction Extensions (2)
- Armboard with 2" pad
- Multi-posture Armboard
- Clark Socket
- Universal Legholder
- Patient Transfer Board with 4"

These are indicated with an asterisk (*) below. Other accessories may be ordered individually or as part of another accessory package (see next page).



T-shaped
Sacral Rest, Adult
BF00073



Wedge-shaped
Sacral Rest, Adult
BF00066*



Sacral Rest,
Child
BF00048



Hip Rest,
carbon fiber
BF00072



Patient Transfer
Board
BF214*

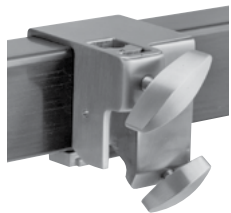

Traction Accessory
Clamp
BF00023*

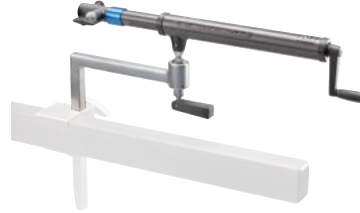

Carbon Fiber
Traction Unit Assembly
BF720*



Traction Boots
Adult - BF721*
Obese Adult - BF722
Child - BF723

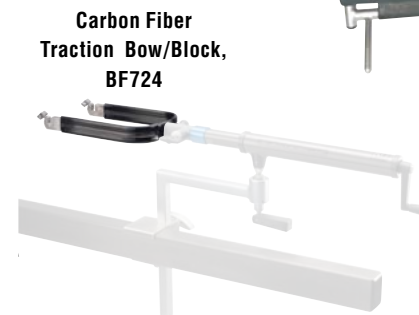

Carbon Fiber
Traction Bow/Block,
BF724

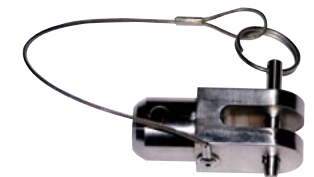

Skeletal
traction block
BF725

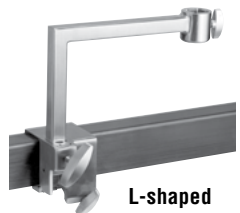

L-shaped
Traction Extension
BF0003*



Straight Traction Extension
BF00268



Tibia/Lateral
Countertraction Support,
carbon fiber
BF00062



Universal
Legholder
BF266*

Accessories (continued)

Accessories indicated with an asterisk (*) below are included in the Orthopedic Extension Accessory Package (BF806). Other accessories may be ordered individually or in one of these accessory packages:

Supplementary Accessory Package (BF808)

Extends procedure capability of the Orthopedic Extension to include lateral patient positioning and skeletal traction

- Tibia/Lateral Countertraction Support
- Hip Rest with pad
- Surgical Drape Support w/Clark Socket & Traction Accessory Clamp
- Straight Traction Extension
- Traction Bow/Block, Skeletal
- Traction Block, Skeletal
- Traction Accessory Clamp

Pediatric Accessory Package (BF809)

Extends procedure capability of the Orthopedic Extension for pediatrics

- Wedge-shaped Sacral Rest w/Pad - Child
- Perineal Post w/o Pad - Child
- Traction Boots - Child, pair
- Hip Spica Assembly - Child

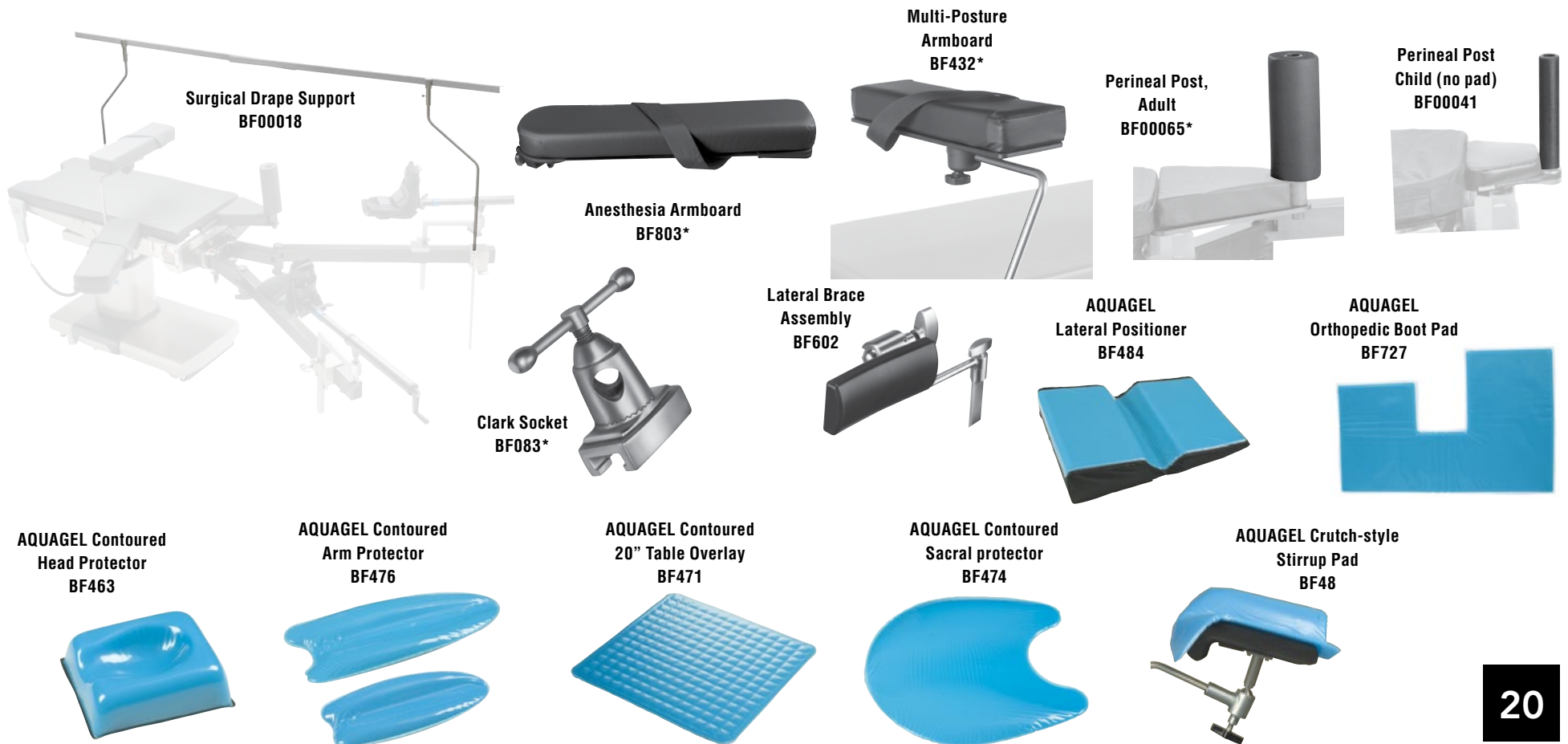

STERIS OFFICES WORLDWIDE

Benelux	32 2 523 2488	Korea	82 2 517 1517
Canada	800 661 3937	Latin America	800 884 9550
China	86 21 6340 6363	Malaysia	6 03 7954 9822
France	33 2 38 745400	Singapore	65 68 41 7677
Germany	49 2203 890 6969	Spain	34 91 658 5920
India	91 33 2367 5150	Sweden	46 8 594 60 550
Italy	39 02 2130341	Switzerland	41 32 376 0200
Japan	81 3 5777 1580	United Kingdom	44 1256 840400

Document # P150832-316 Rev. 1, B/P 01-05-07
GPSI Printed 04/2007, 400

©2007 STERIS Corporation.
All rights reserved. Printed in USA.

STERIS®



STERIS Corporation
5960 Heisley Road
Mentor, OH 44060-1834 ■ USA
440-354-2600 ■ 800-548-4873
www.steris.com